



# DARWIN



Universität  
Zürich<sup>UZH</sup>



## DARWIN – a next-generation observatory for dark matter and neutrino physics

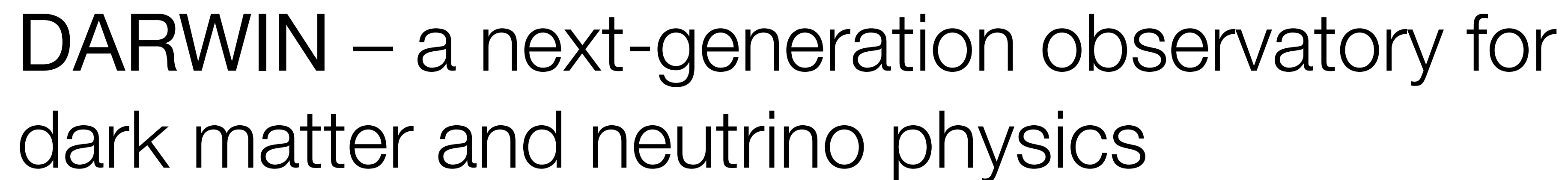

Kevin Thieme  
University of Zurich

on behalf of the DARWIN collaboration

# DARWIN Collaboration



- Over 160 scientists
- 33 institutions
- 13 countries
- Large overlap with XENON Collaboration

# Evolution from XENON10 to DARWIN

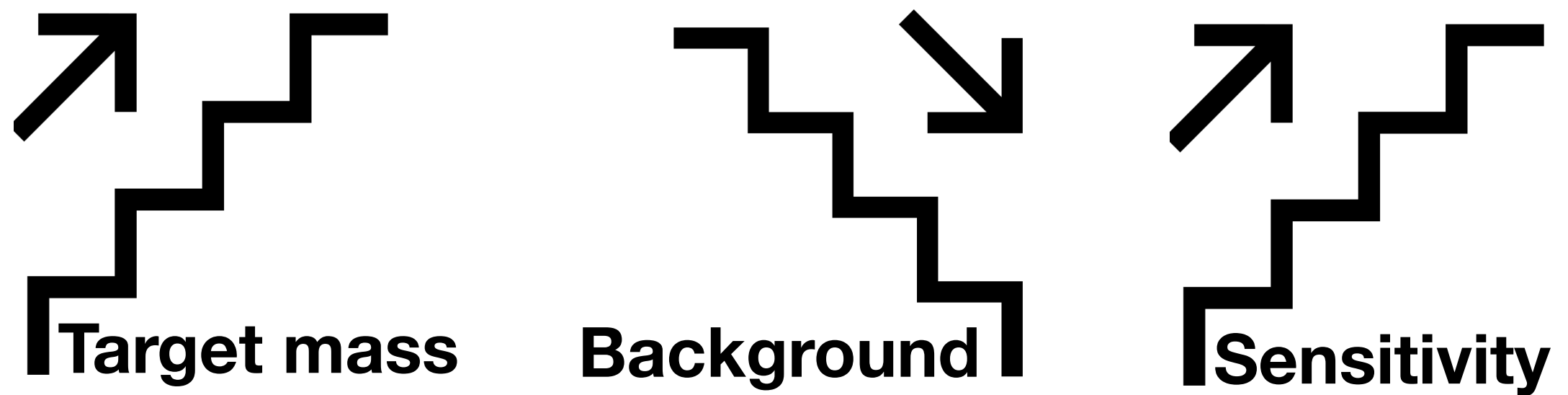
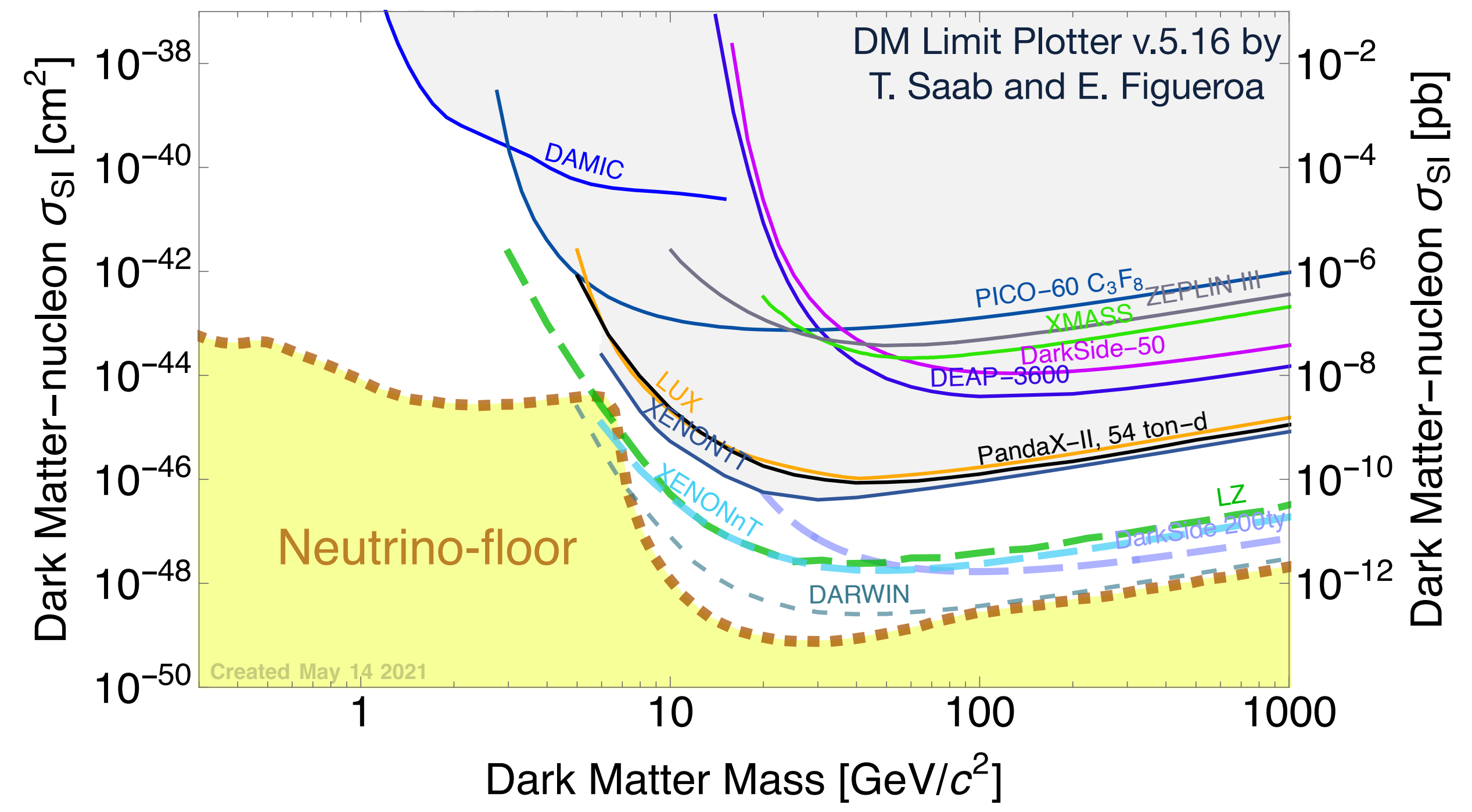
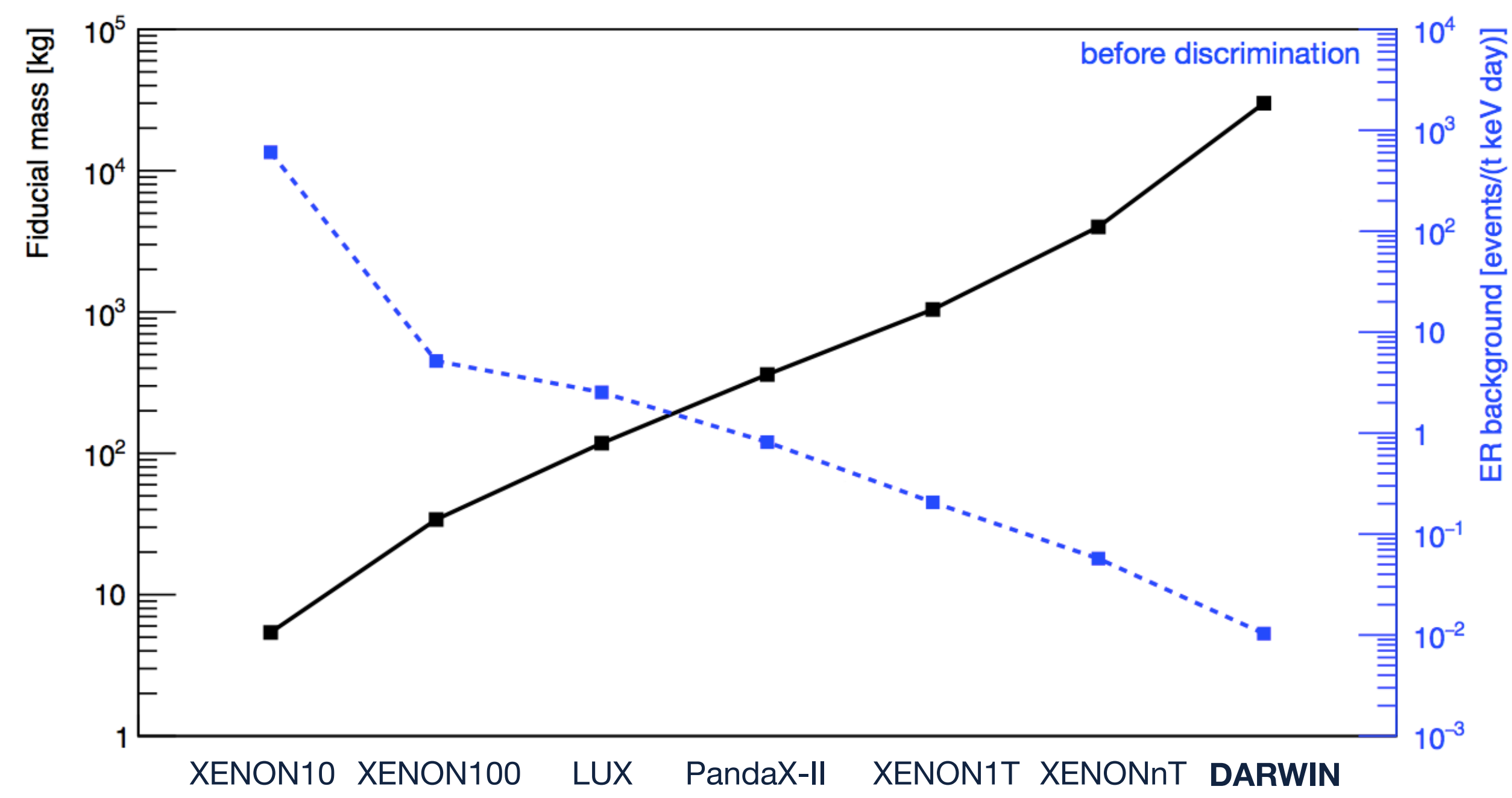

- Hunt for WIMPs from ~GeV to ~TeV led by liquid noble gas experiments
- DARWIN aims to push near-future sensitivities by an order of magnitude down to the irreducible CE $\nu$ NS background

# Dual-Phase Xenon Time Projection Chamber

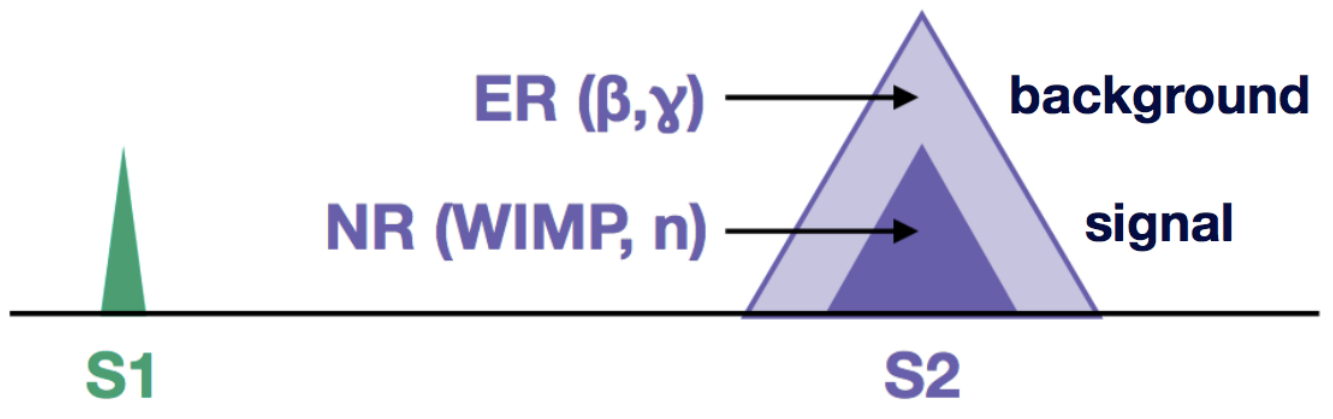
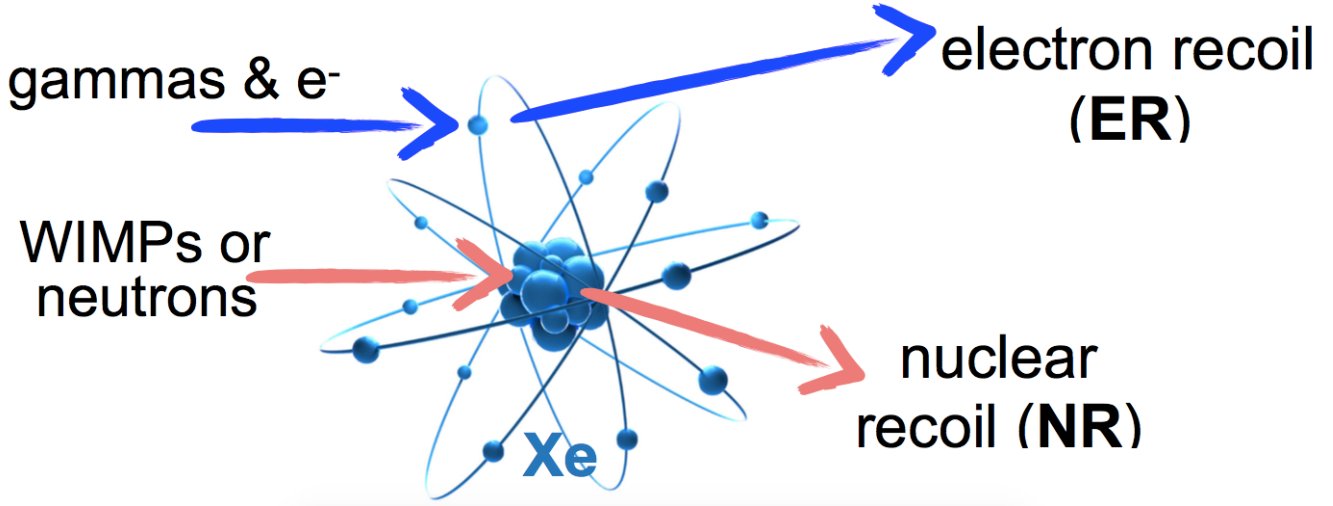
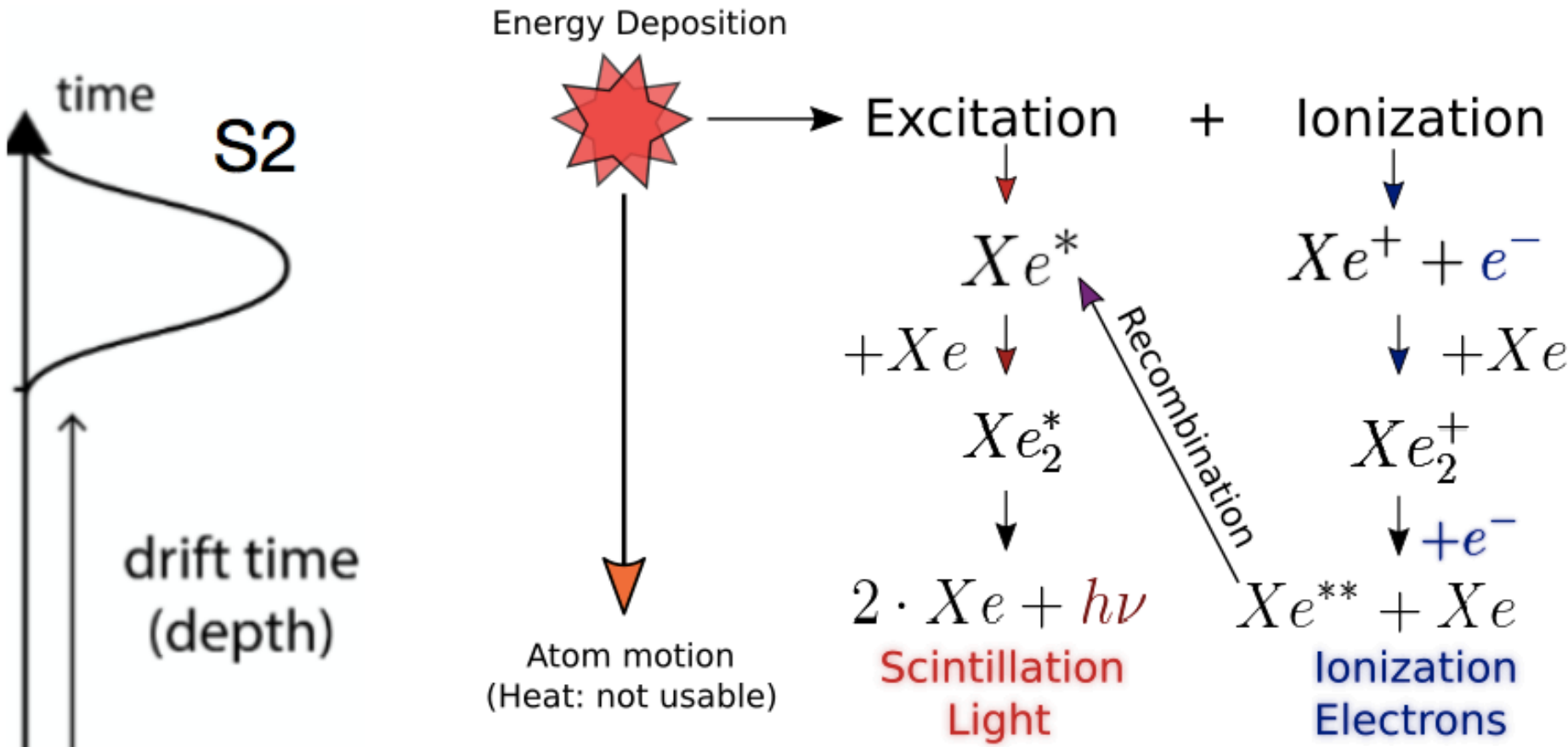
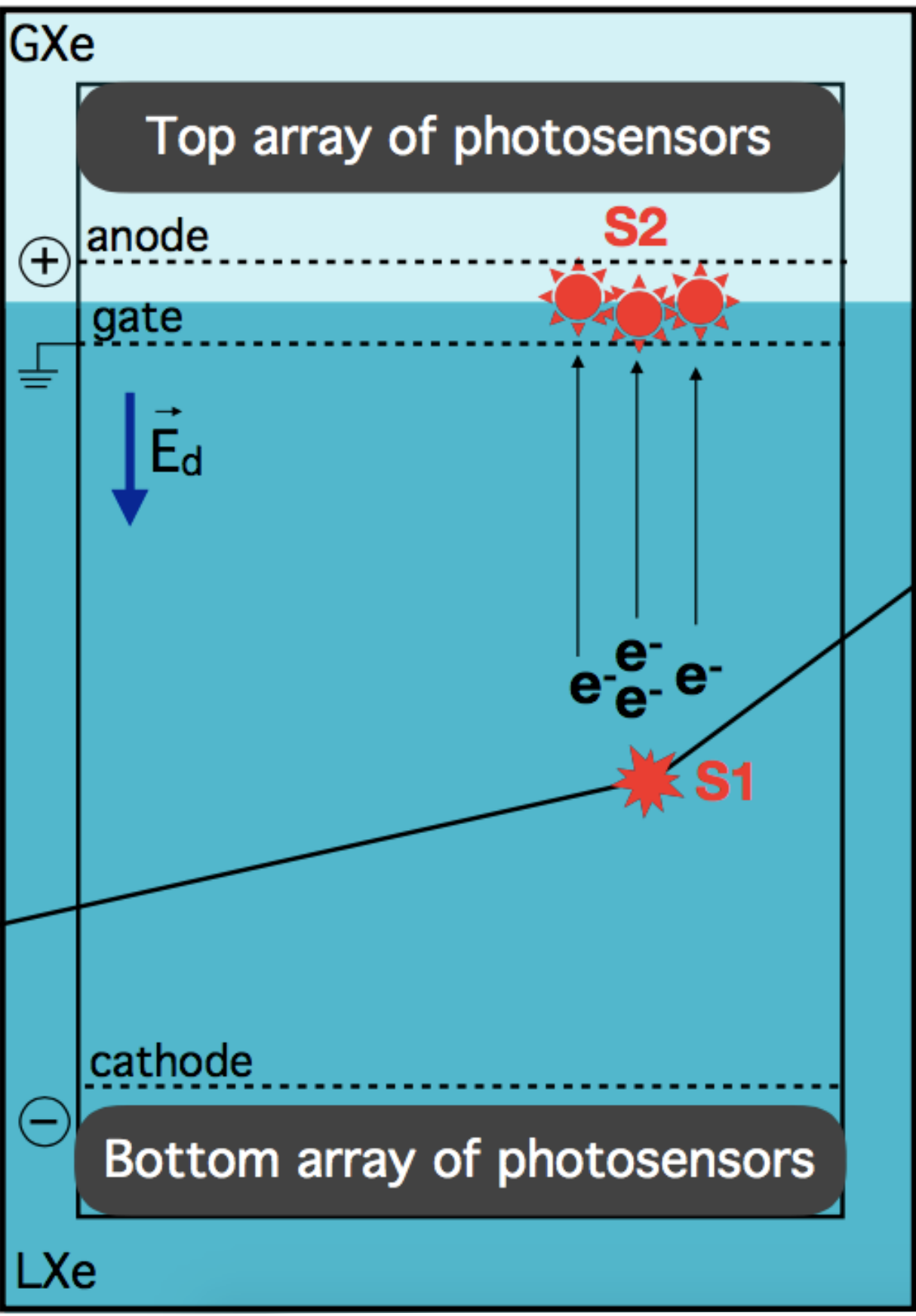

- Detection of prompt scintillation (S1) and delayed ionisation signal (S2)
- 3D position reconstruction
- ER/NR discrimination based on S1/S2 ratio

# Baseline Design

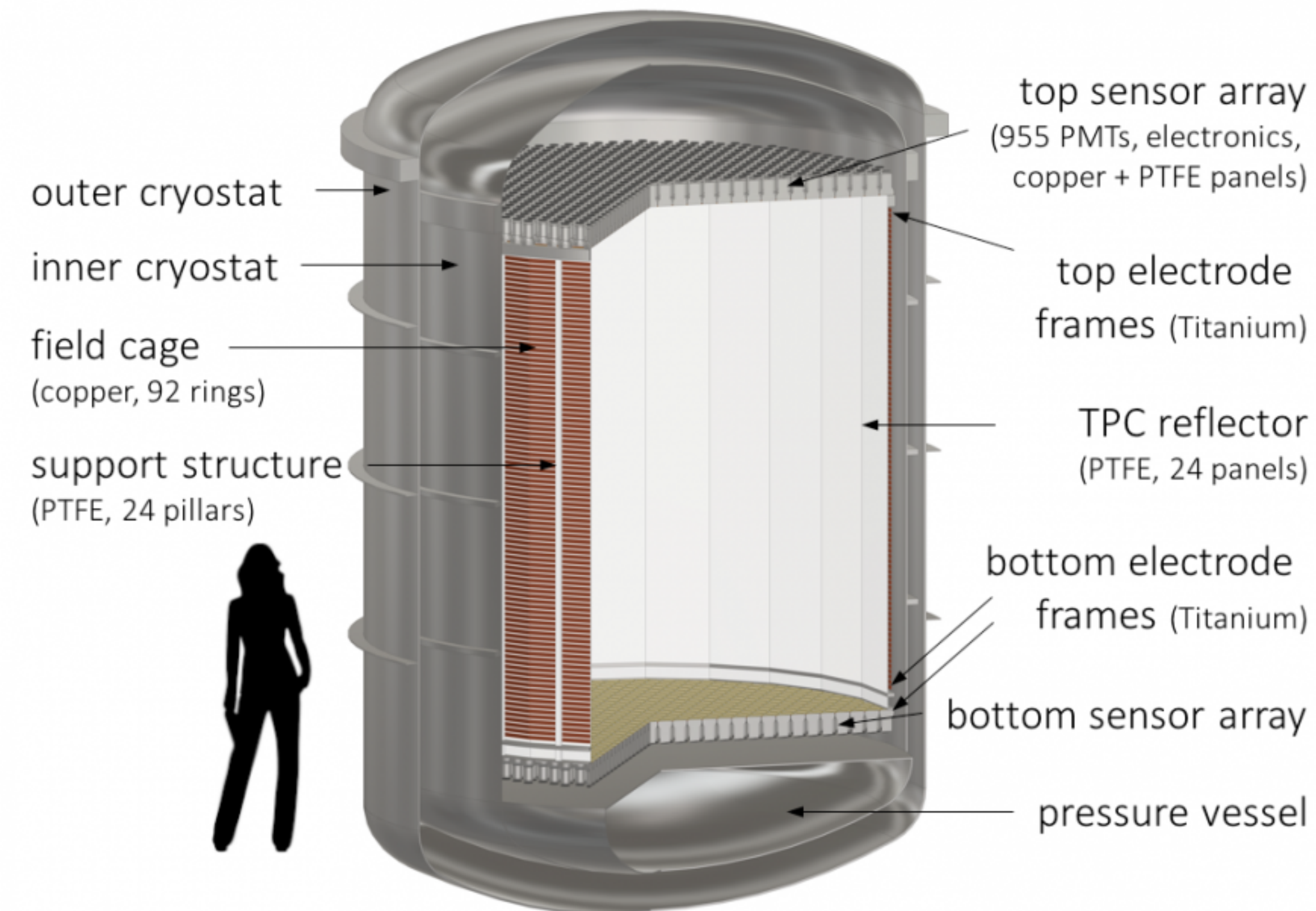

- 2.6 m x 2.6 m dual phase TPC in a double-walled cryostat
- 50 t (40 t active) liquid xenon (LXe) target
- Top and bottom array of 3-inch PMTs
- Surrounded by highly reflective PTFE walls
- Drift field  $\mathcal{O}(0.1)$  kV/cm
- Inner neutron veto
- Min. 12 m  $\times$  12 m water Cherenkov shield and muon veto

JCAP11 (2016) 017

# Expected Events in DARWIN

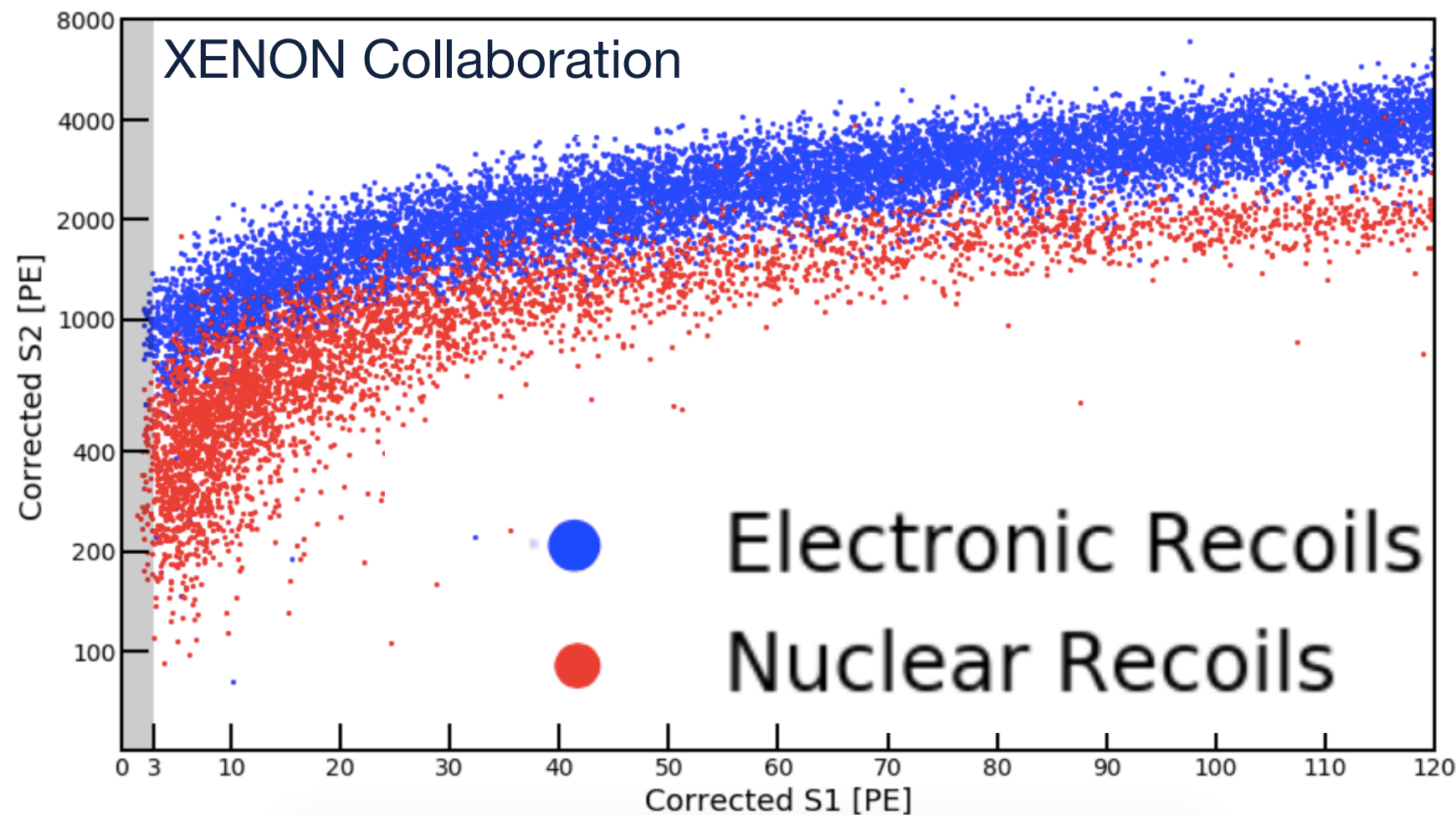

...background to one, signal for another channel...

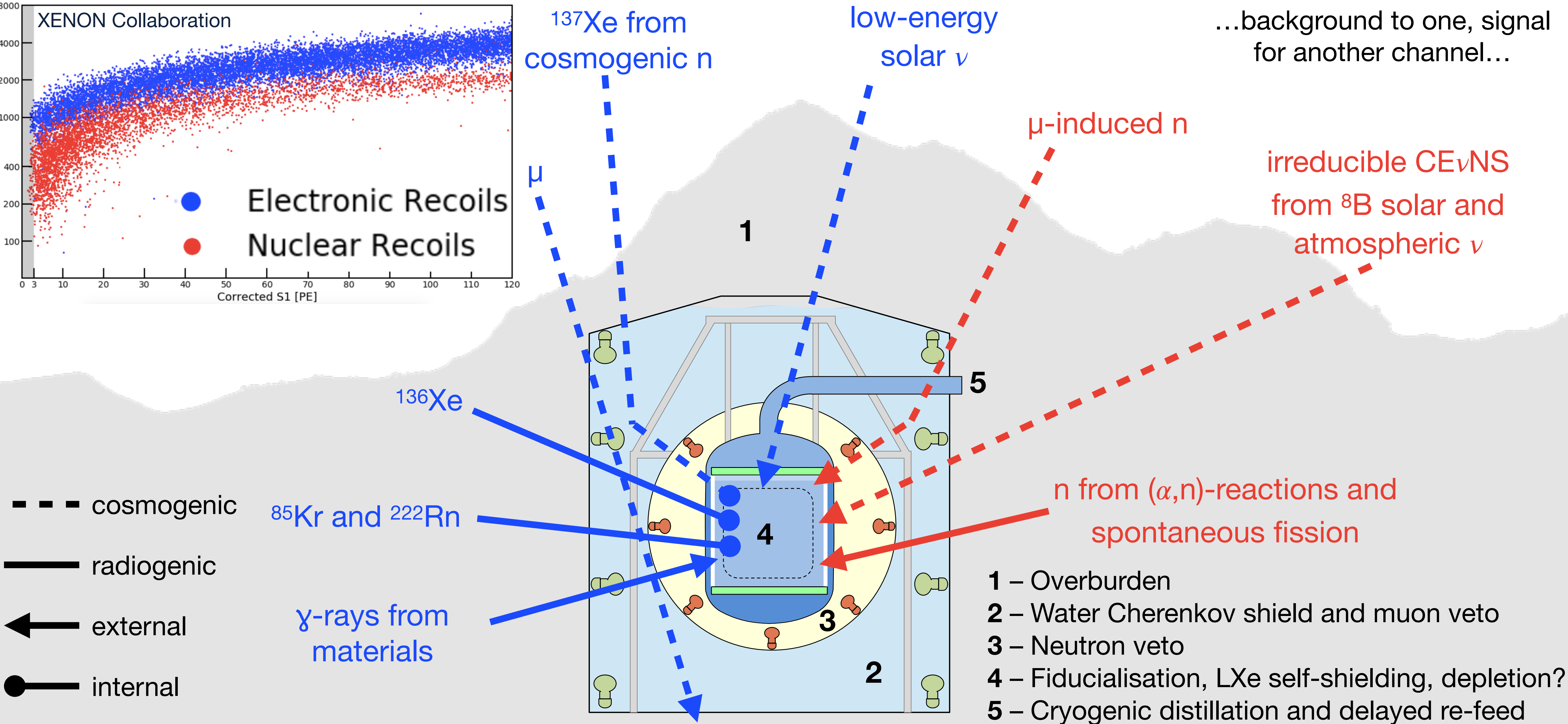

- cosmogenic
- radiogenic
- ← external
- internal

# WIMP Dark Matter



- 30 t fiducial volume and 200 t x y exposure
- 99.98% ER rejection -> achieved by ZEPLIN-III ✓  
Phys. Rev. D 80 (2009) 052010
- at 30 % NR acceptance
- 0.1 ppt natKr -> XENON achieved 0.03 ppt in distillation test ✓  
Eur. Phys. J. C 77 (2017) 275
- 0.1 μBq/kg <sup>222</sup>Rn -> push by another order of magnitude
- 8 PE/keV light yield

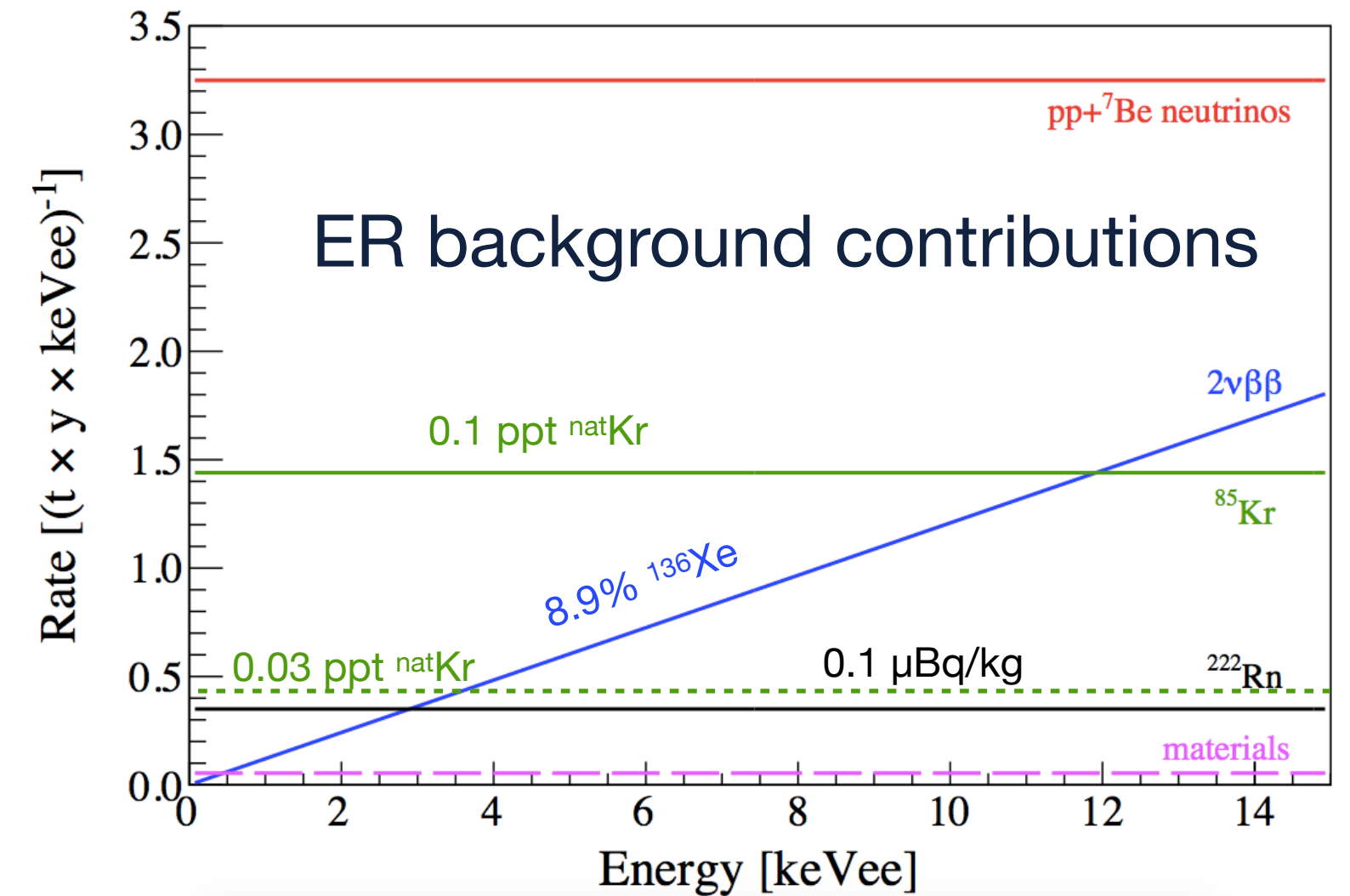

JCAP10 (2015) 016

JCAP11 (2016) 017

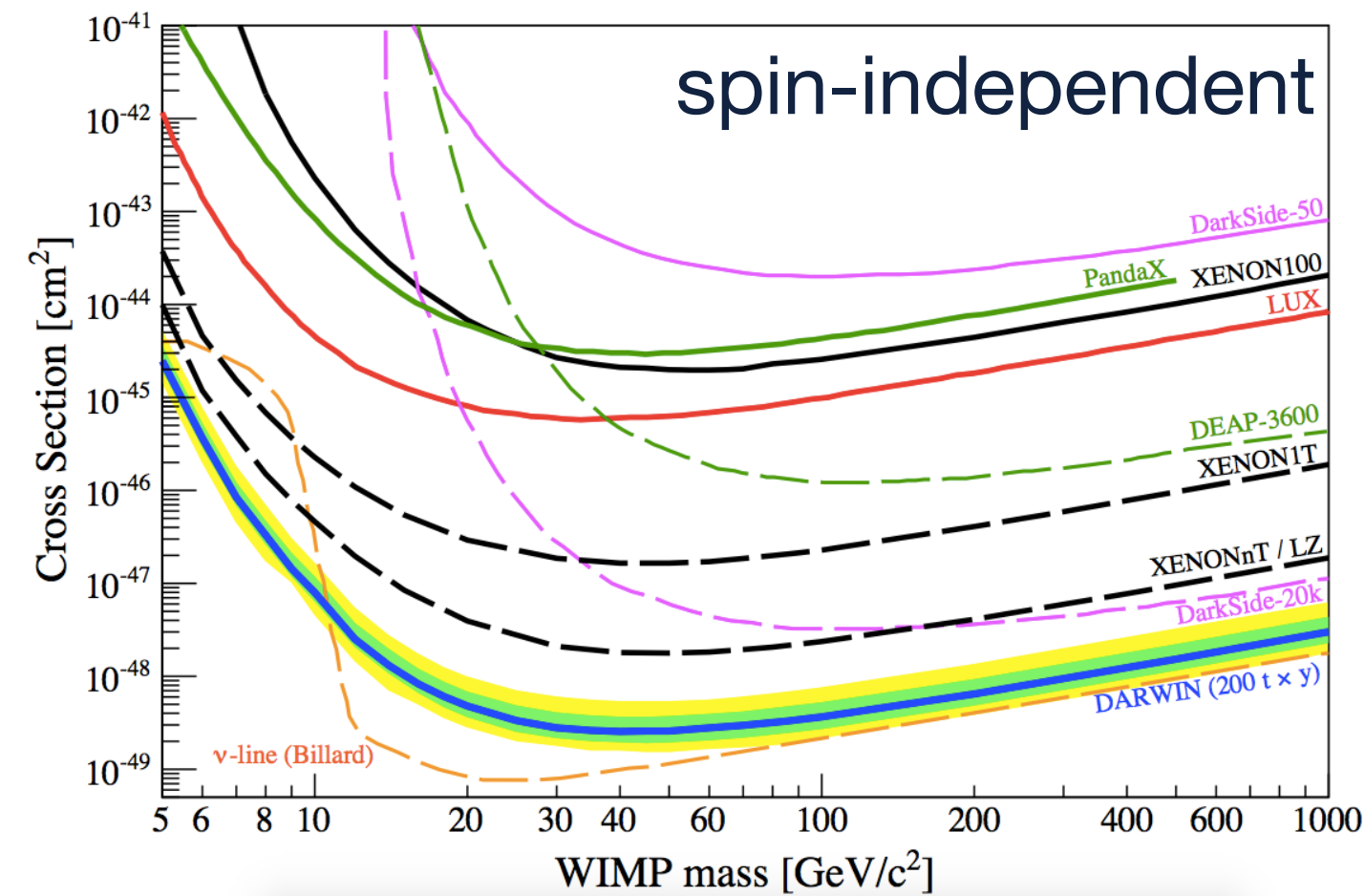

$2.5 \times 10^{-49} \text{ cm}^2$  at 40 GeV/c<sup>2</sup>

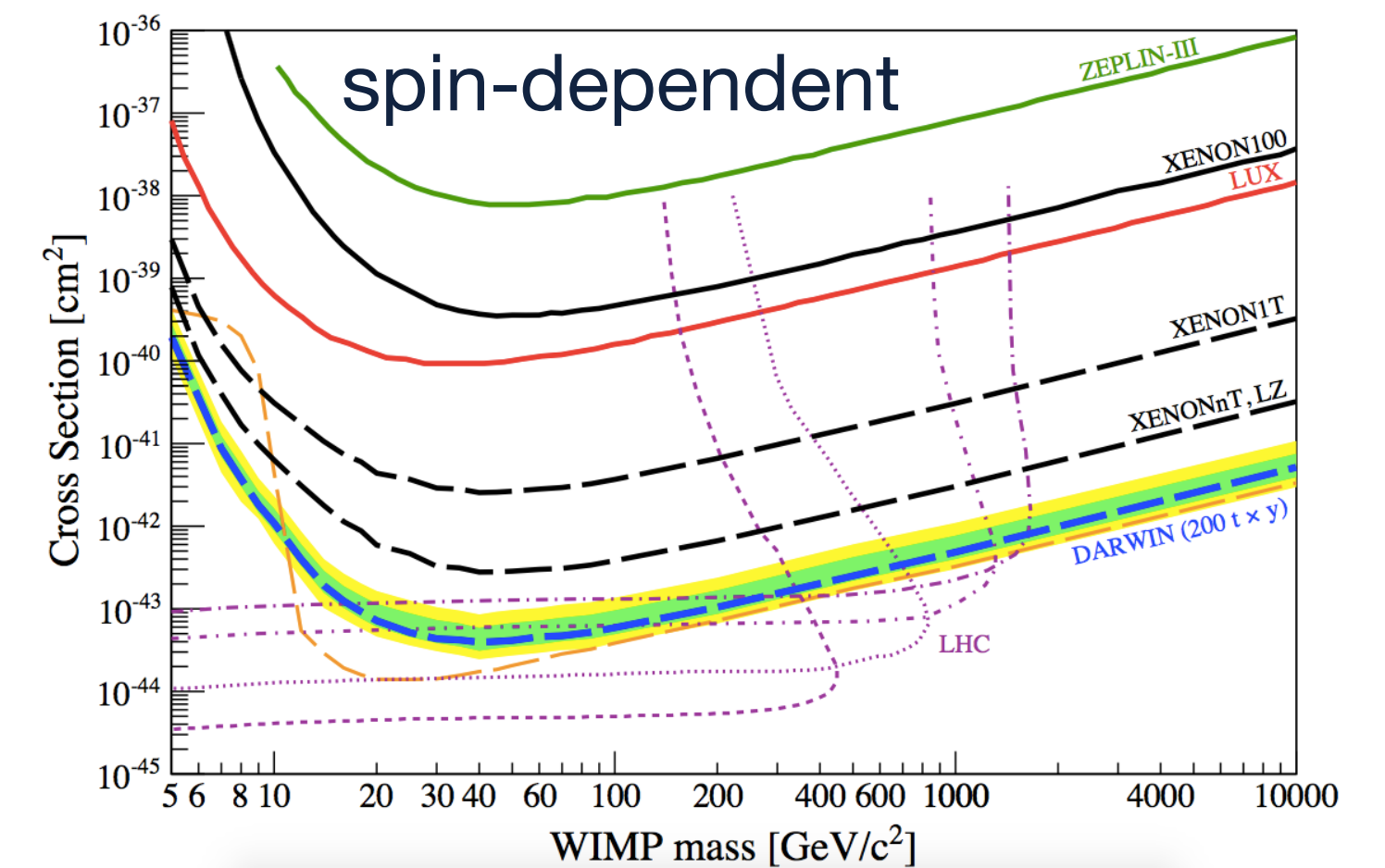

complementary to 14 TeV LHC

# A Multipurpose Observatory



The large mass, low energy threshold and ultra-low background makes a variety of other channels accessible...

This talk	<b>Neutrinoless Double Beta Decay with <math>^{136}\text{Xe}</math></b>	EPJ C 80 (2020) 808
	<b>Low-Energy Solar Neutrinos</b>	EPJ C 80 (2020) 1133
	<b>Galactic Supernova Neutrinos</b>	PR D94 (2016) 103009
New studies ongoing	<b>Coherent Neutrino-Nucleus Scattering</b>	JCAP11 (2016) 017
	<b>Solar Axions and Galactic Axion-like Particles</b>	
	...	



# Neutrinoless Double Beta Decay



- Natural abundance of  $^{136}\text{Xe}$  is 8.9%  $\rightarrow$   $\sim 3.5$  t active mass without enrichment
- Q-value is 2458 keV  $\rightarrow$  well above WIMP region
- Background from materials,  $^{137}\text{Xe}$ ,  $^{222}\text{Rn}$ , solar  $^8\text{B}$   $\nu$ ,  $2\nu\beta\beta$  of  $^{136}\text{Xe}$
- Optimised 5 t fiducial mass
- Sensitivity of baseline scenario after 10 y:  $T_{1/2} = 2.4 \times 10^{27}$  y (90 % CL)  $\rightarrow$   $3\sigma$  discovery potential:  $1.1 \times 10^{27}$  y
- Will cover inverted hierarchy Majorana mass region
- Competitive to future dedicated experiments

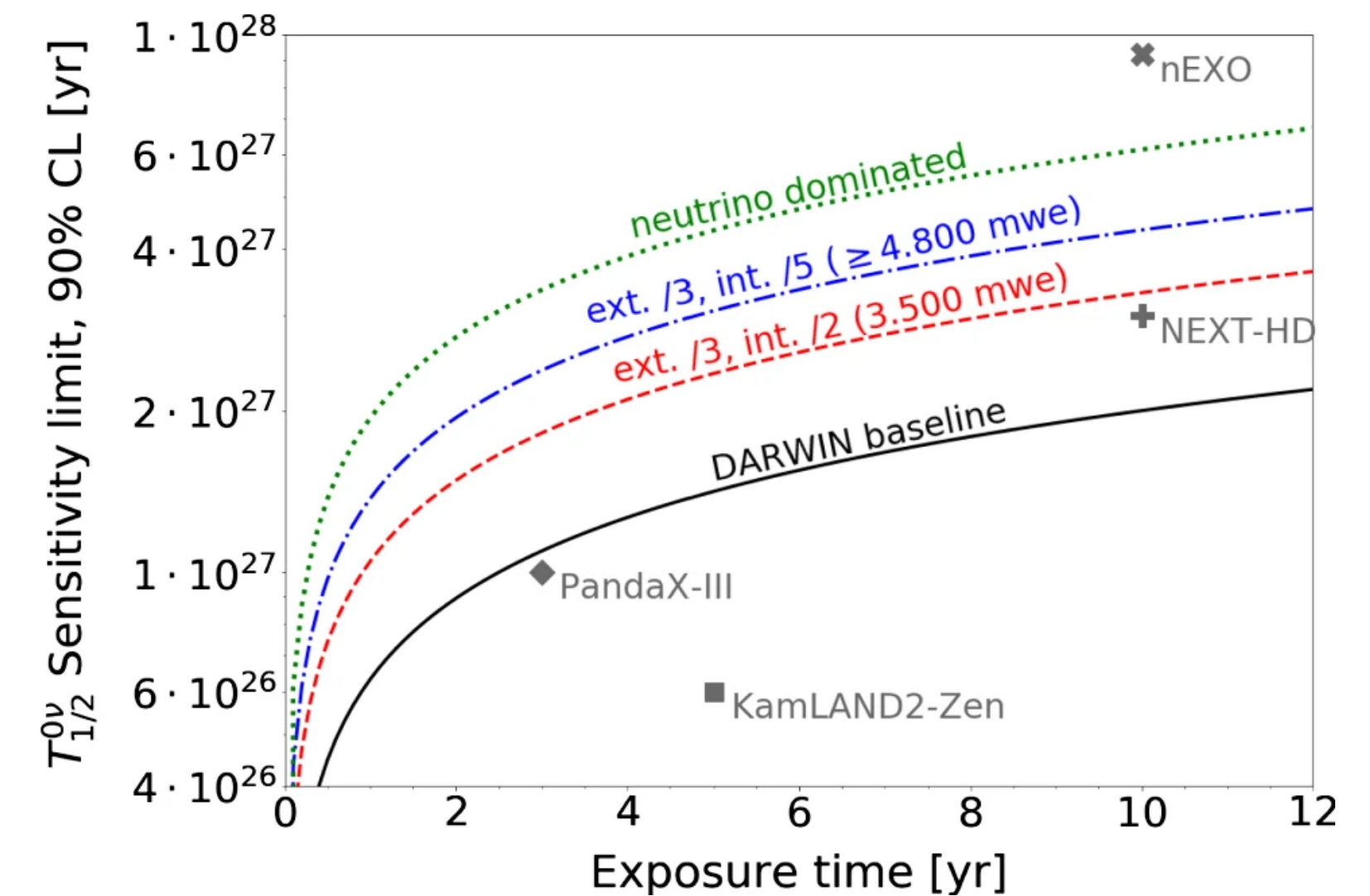
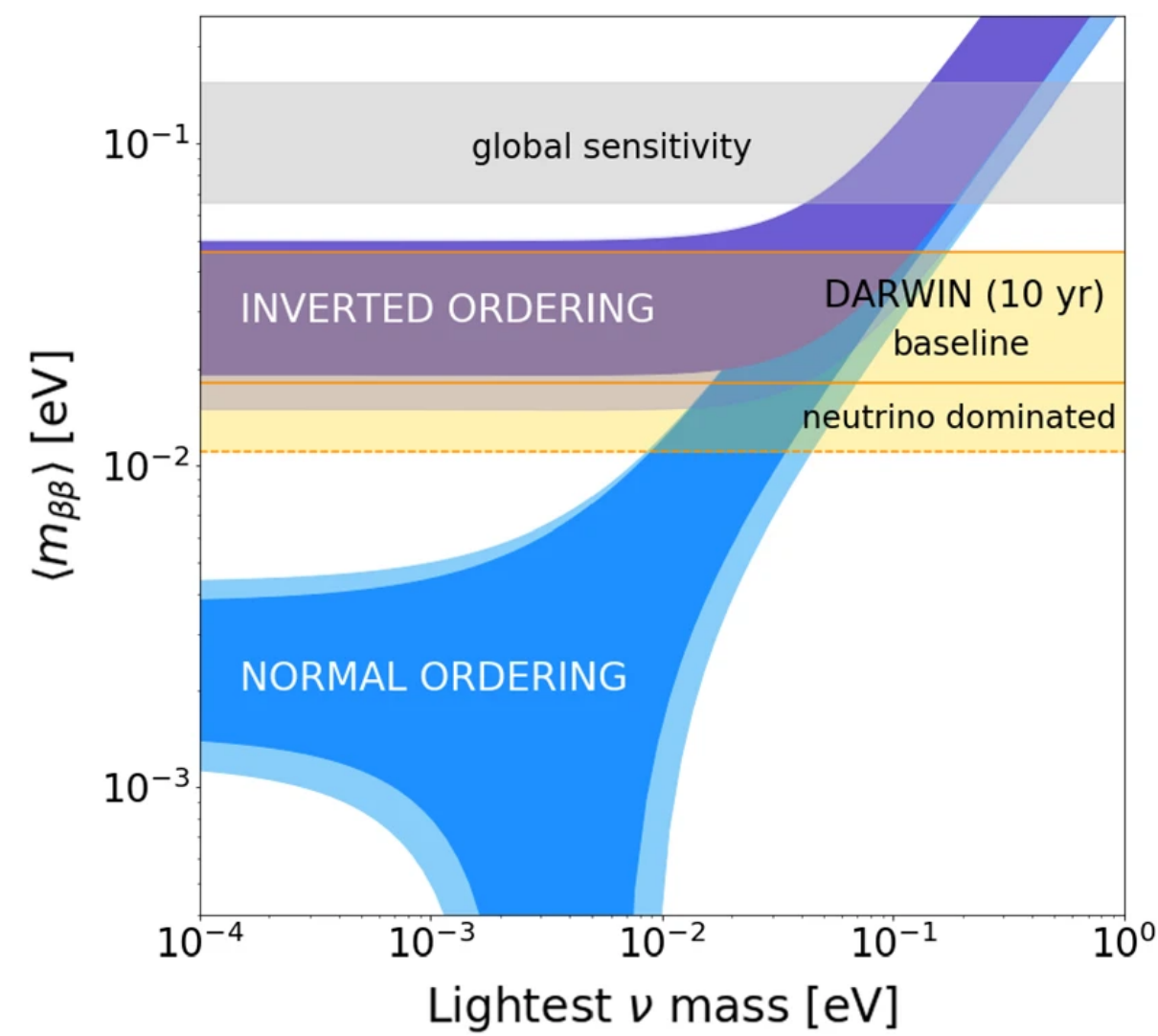
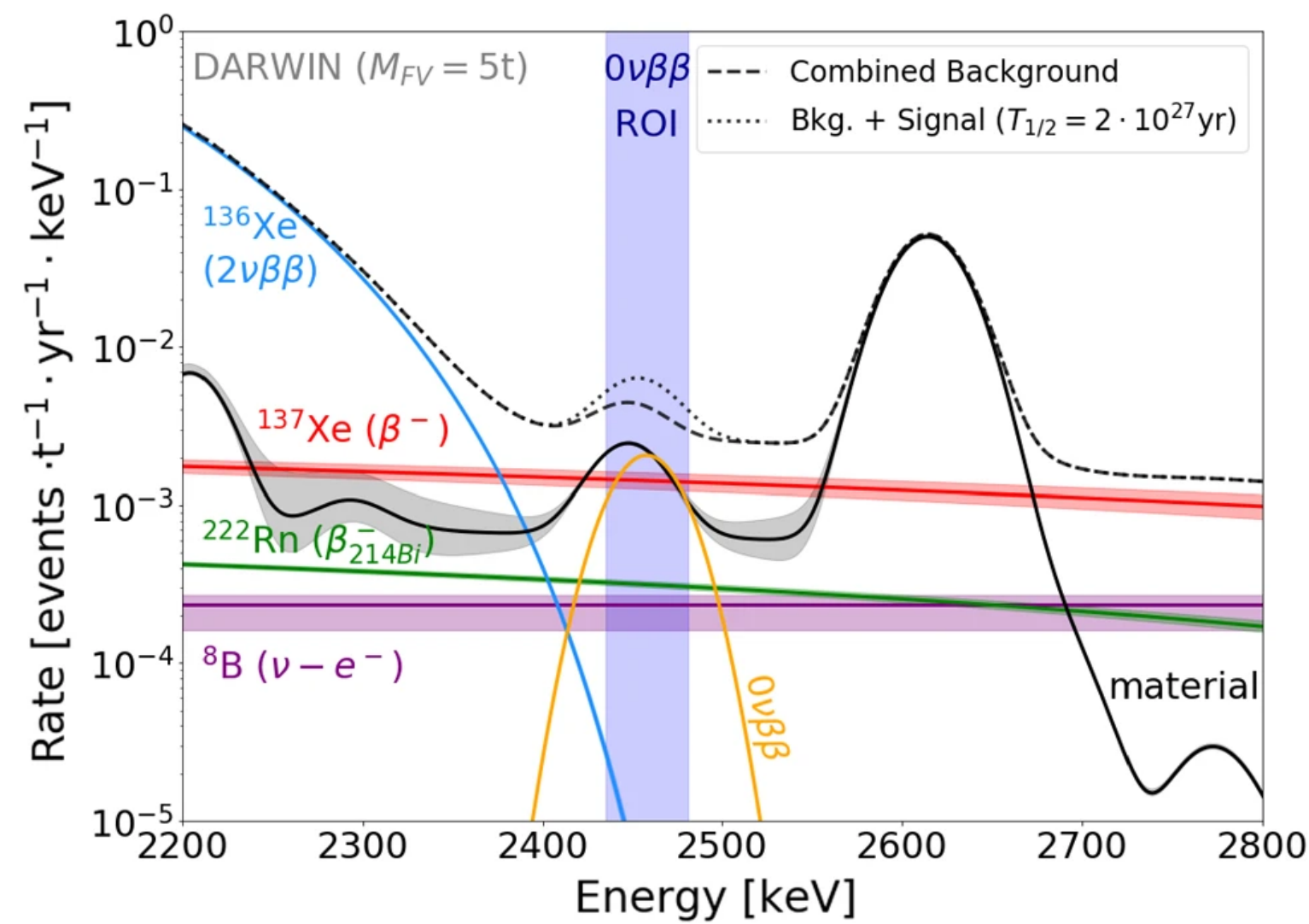

Eur. Phys. J. C 80 (2020) 808

# Low-Energy Solar Neutrinos



- pp and  ${}^7\text{Be}$  neutrinos account for  $> 98\%$  of solar neutrino flux (SSM)
- Detection via elastic electron scattering
- Background from  $2\nu\beta\beta$  of  ${}^{136}\text{Xe}$ , materials,  ${}^{222}\text{Rn}$ ,  ${}^{85}\text{Kr}$ , DEC of  ${}^{124}\text{Xe}$
- 30 t fiducial volume
- High-precision pp ( ${}^7\text{Be}$ ) flux measurement  $\rightarrow 0.15\%$  (1%) after 300 t x y
- Measurement of  $\nu_e$  survival probability (4.0 % precision) and neutrino mixing angle (5.1 % precision) below 200 keV
- ${}^{13}\text{N}$ ,  ${}^{15}\text{O}$  within reach, but pep and  $\nu$ -capture on  ${}^{131}\text{Xe}$  requires depletion

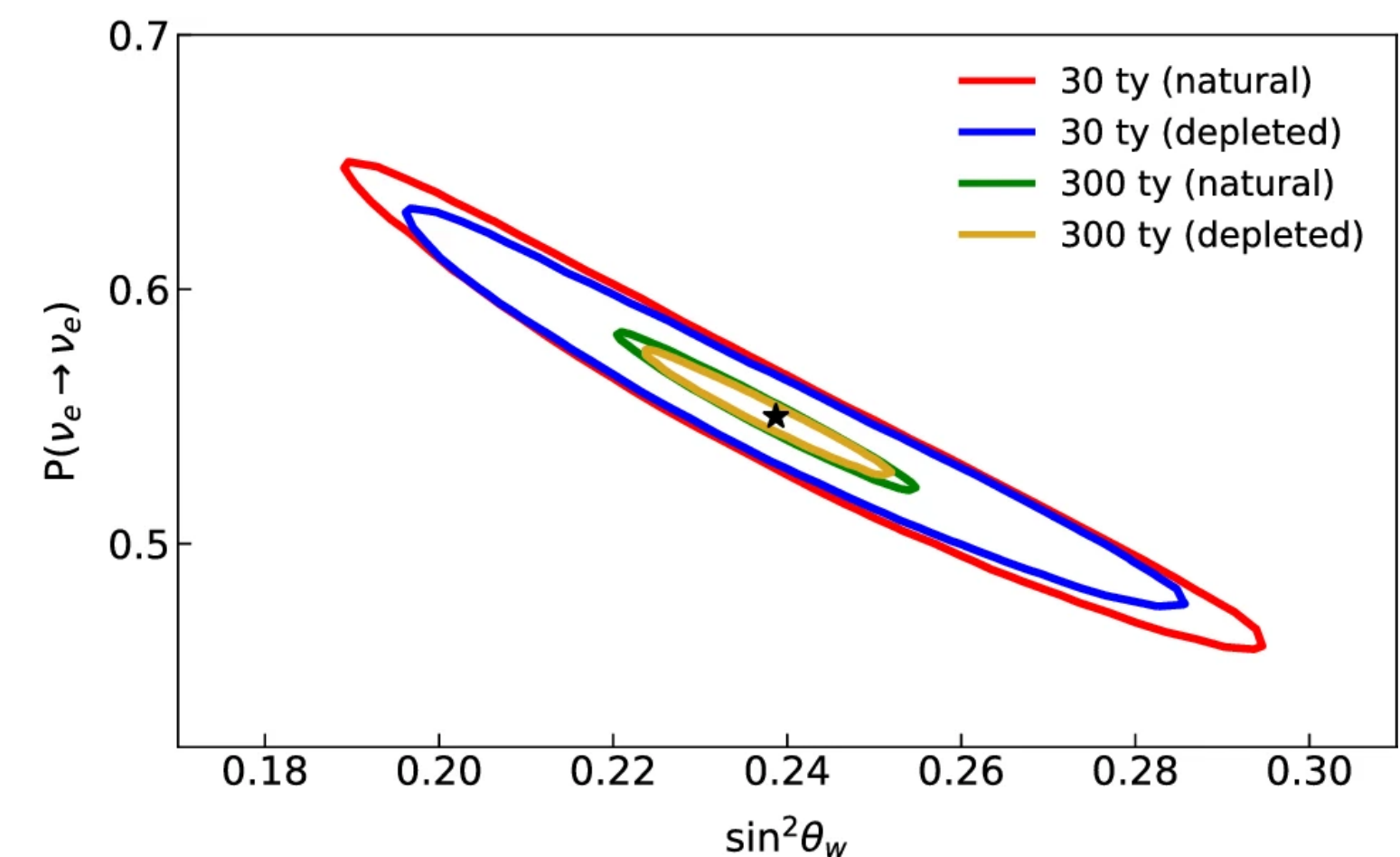
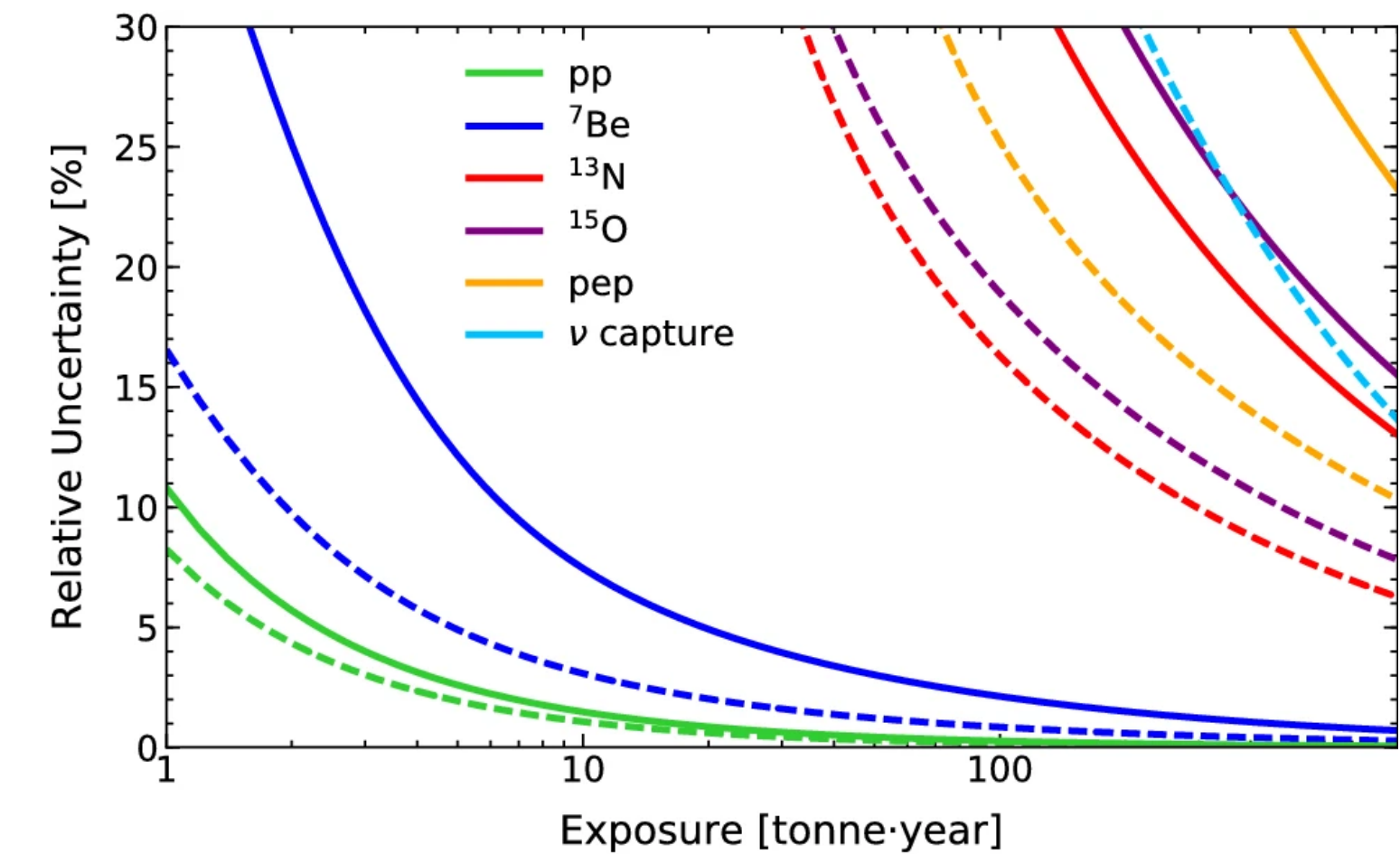
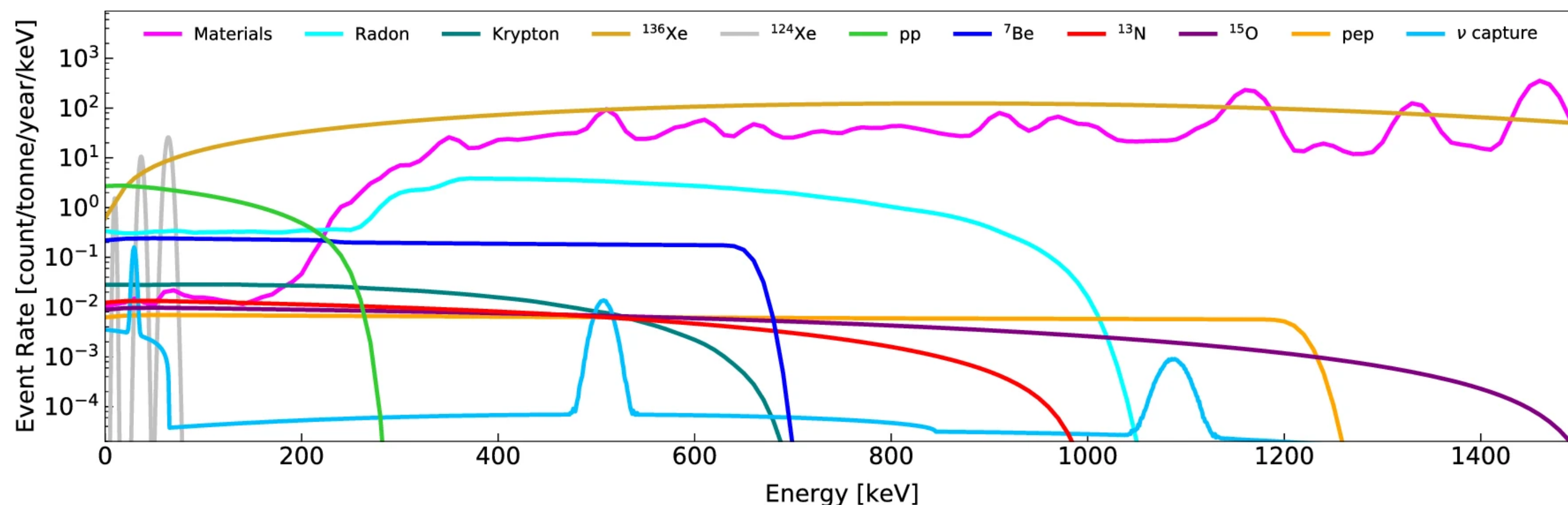

Eur. Phys. J. C 80 (2020) 1133



# Status and Schedule



- Working towards CDR and TDR
- DARWIN is in the APPEC roadmap
- Letter of Intent submitted to LNGS in 2019 with positive feedback
- Supported by two ERC grants for R&D (Xenoscope @ Zurich CH, ULTIMATE @ Freiburg GER)

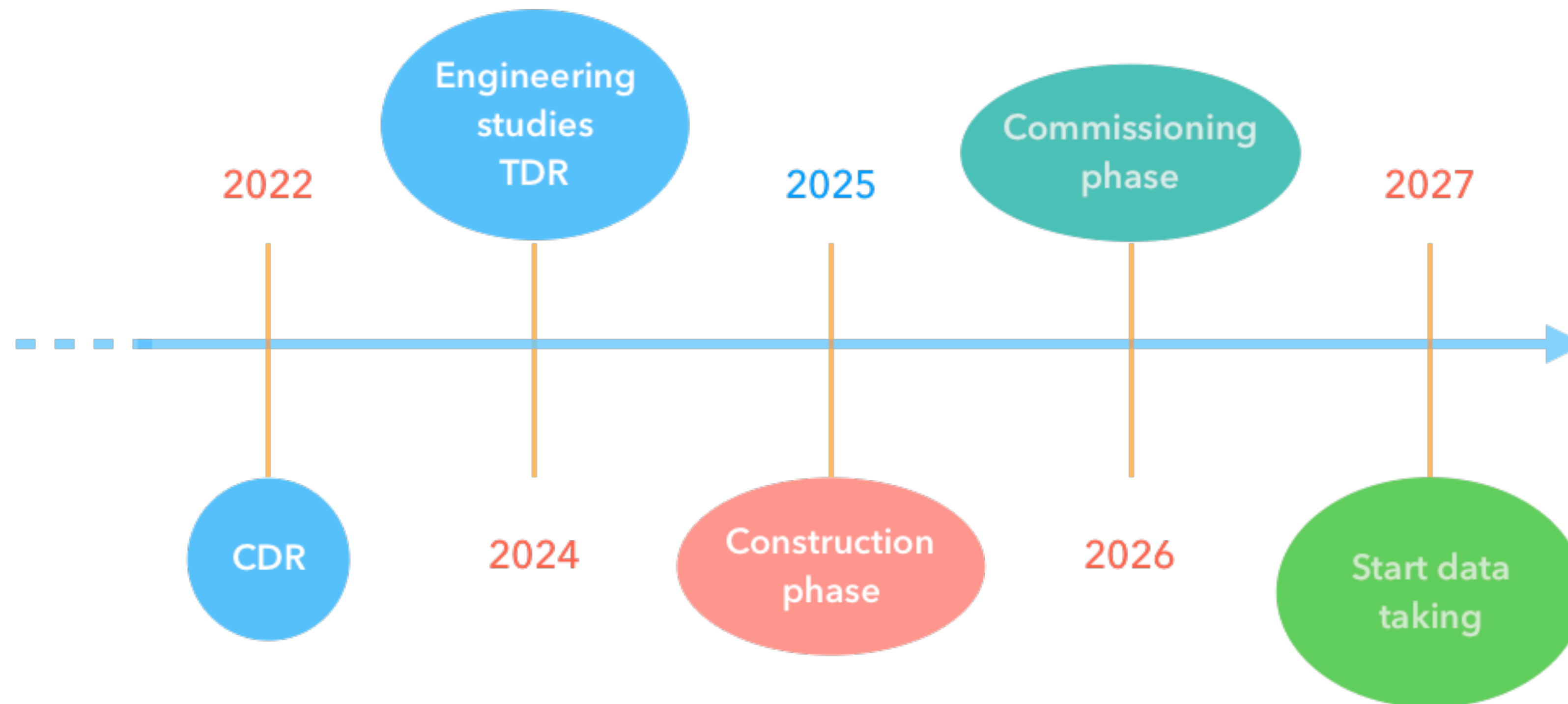



# DARWIN-LZ Collaboration



- Future merger of DARWIN and LUX-ZEPLIN Collaborations
  - > new, stronger international collaboration
- Comes after XENONnT and LZ are done
- First joint and successful DARWIN LZ Meeting (26–27 April): <https://indico.cern.ch/event/1028794/>
- Memorandum of Understanding in progress



# Ongoing R&D: Full-scale Demonstrators

➔ Test instrumentation and detector technology at DARWIN scale



Universität  
Zürich UZH

## Full-Height

arXiv:2105.13829

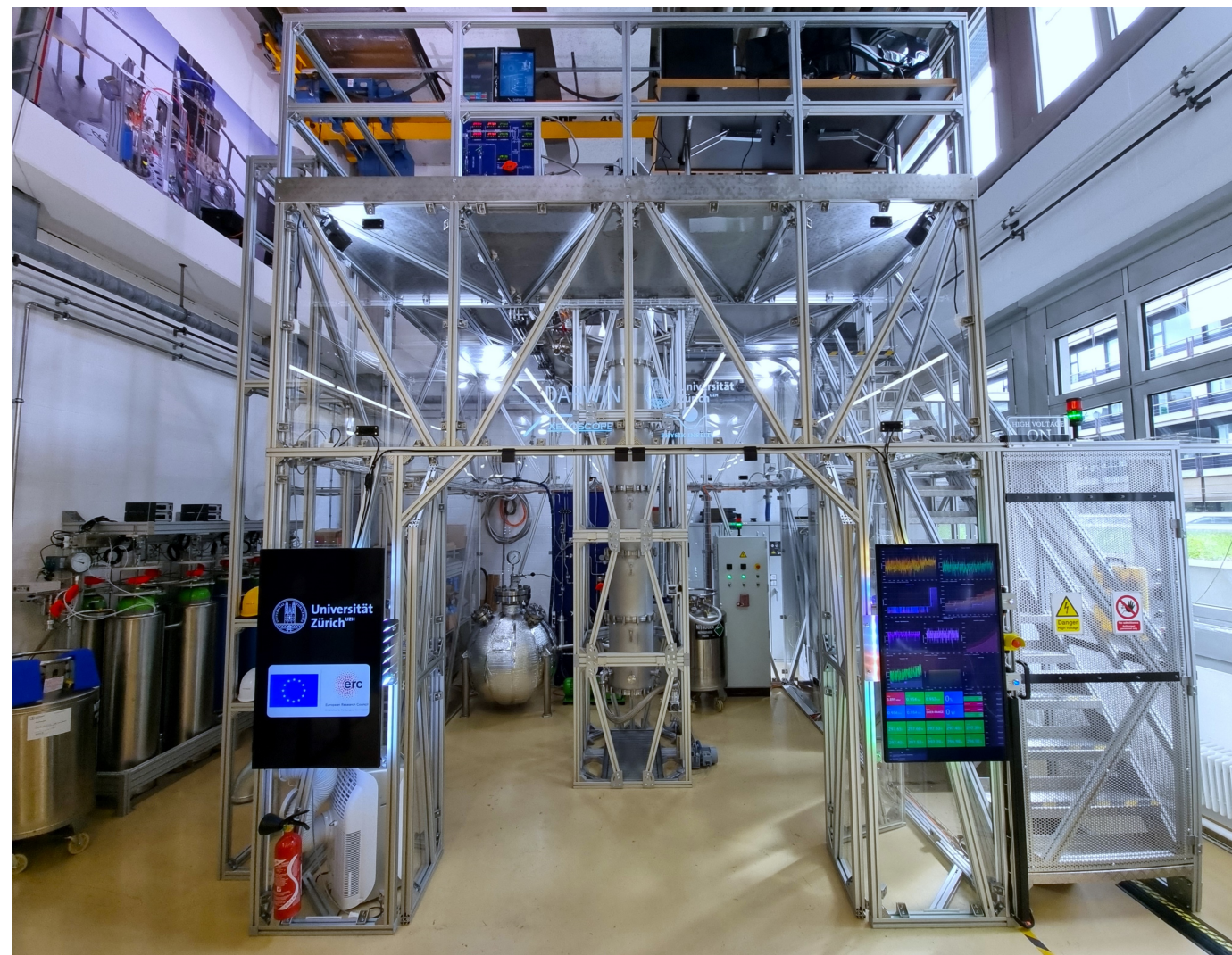

- Demonstrate 2.6 m electron drift and study purity requirements
- Test optical properties of xenon
- R&D on HV feedthrough

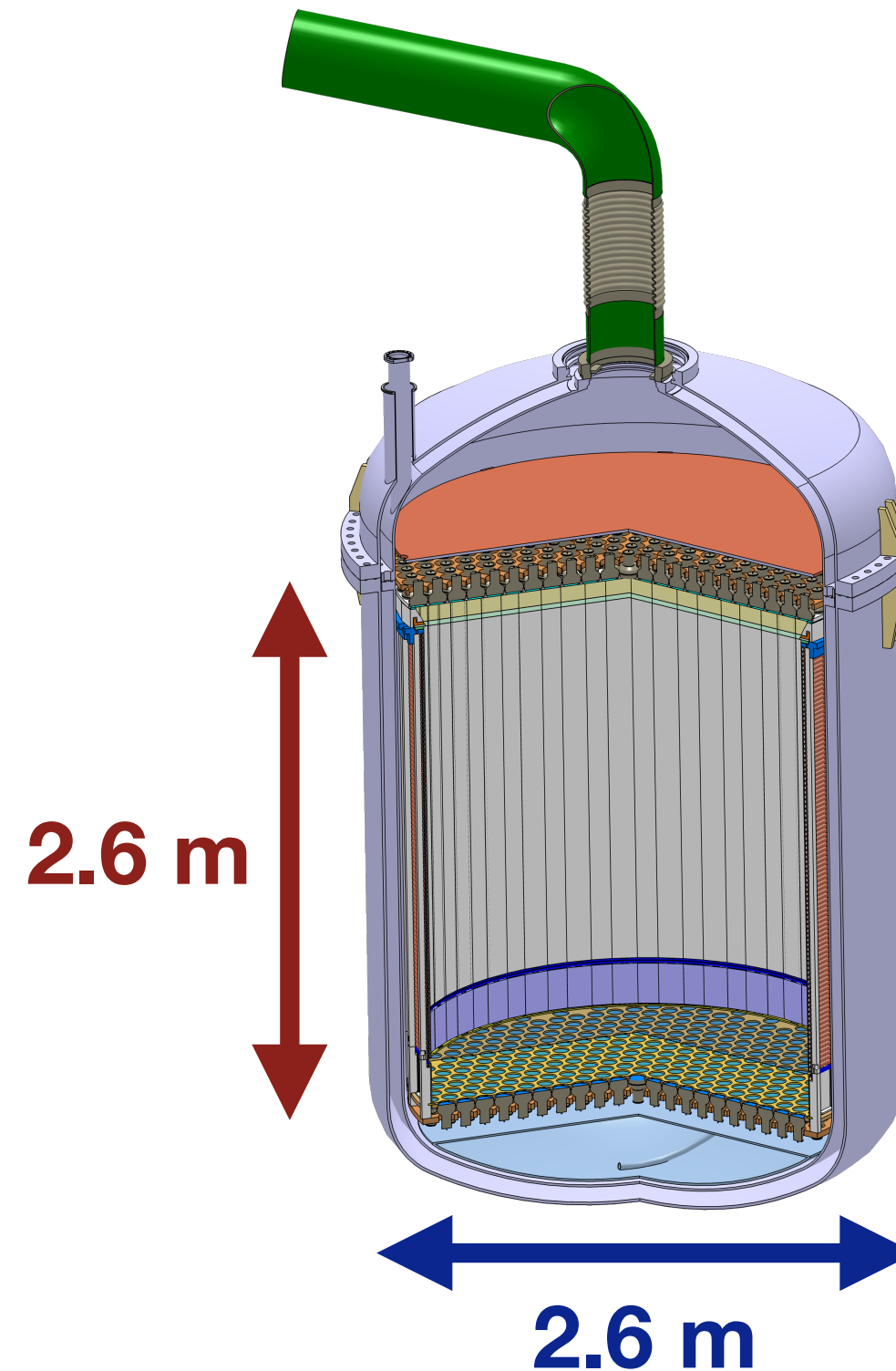

## Full-Diameter



- Mechanical and electrical test of electrodes
- Test detector materials under cryogenic conditions
- Address sagging, shrinkage, uniform S2-amplification



## Photosensors

- Alternative to 3-inch PMT 11410 from Hamamatsu
- Goal: Reduce background contribution, maximise light collection and position resolution, good SPE resolution
- Address dark count rate, readout, number of channels
- SiPM [1–4], Digital SiPM, ABALONE [5], VSiPMT [6], Liquid Hole Multipliers [7], 2-inch square PMTs, ...

## Material, Radon Background Mitigation and Screening

- Material coating to reduce radon emanation
- Low-background screening facilities [8–9] and radon emanation chamber

## Detector Design

- Optimise established TPC design and consider alternatives
- Hermetic TPC for radon lock-out [10]
- Single Phase LXe TPC with S2-production on thin wires

[1–4] JINST 13 (2018) P10022, Nucl. Instrum. Meth. A 893 (2018) 117, Eur. Phys. J. C 80 (2020) 477, JINST 16 (2021) P03014

[5] arXiv:1703.04546

[6] Astropart. Phys. 67 (2015) 18

[7] JINST 15 (2020) C04002

[8–9] JINST 6 (2011) P08010, JINST 11 (2016) P12017

[10] PTEP 2020 (2020) 11, 113H02



# DARWIN Observatory – Summary



- **DARWIN** will be the **ultimate dark matter detector**, probing a wide mass range and WIMP-nucleon cross sections down to the irreducible background of coherent neutrino-nucleus interactions
- **Dual-phase TPC** with **50 t xenon** (40 t active) deep underground with neutron veto, water Cherenkov muon veto and shield
- The large mass, low-energy threshold and ultra-low background will open **a large variety of accessible physics channels**: WIMPs,  $0\nu\beta\beta$ , low-energy solar neutrinos, galactic supernova neutrinos, CEvNS, solar axions and galactic ALPs
- Competitive  **$0\nu\beta\beta$**  half life sensitivity and high-precision measurements of the **low-energy solar neutrino fluxes**
- DARWIN is growing, currently 33 institutions from 13 countries
- Future merger with **LUX-ZEPLIN collaboration**
- R&D: 2 full-scale demonstrators, photosensors, detector design, background mitigation -> supported by two **ERC Grants**: Xenoscope (Zurich CH), ULTIMATE (Freiburg GER)

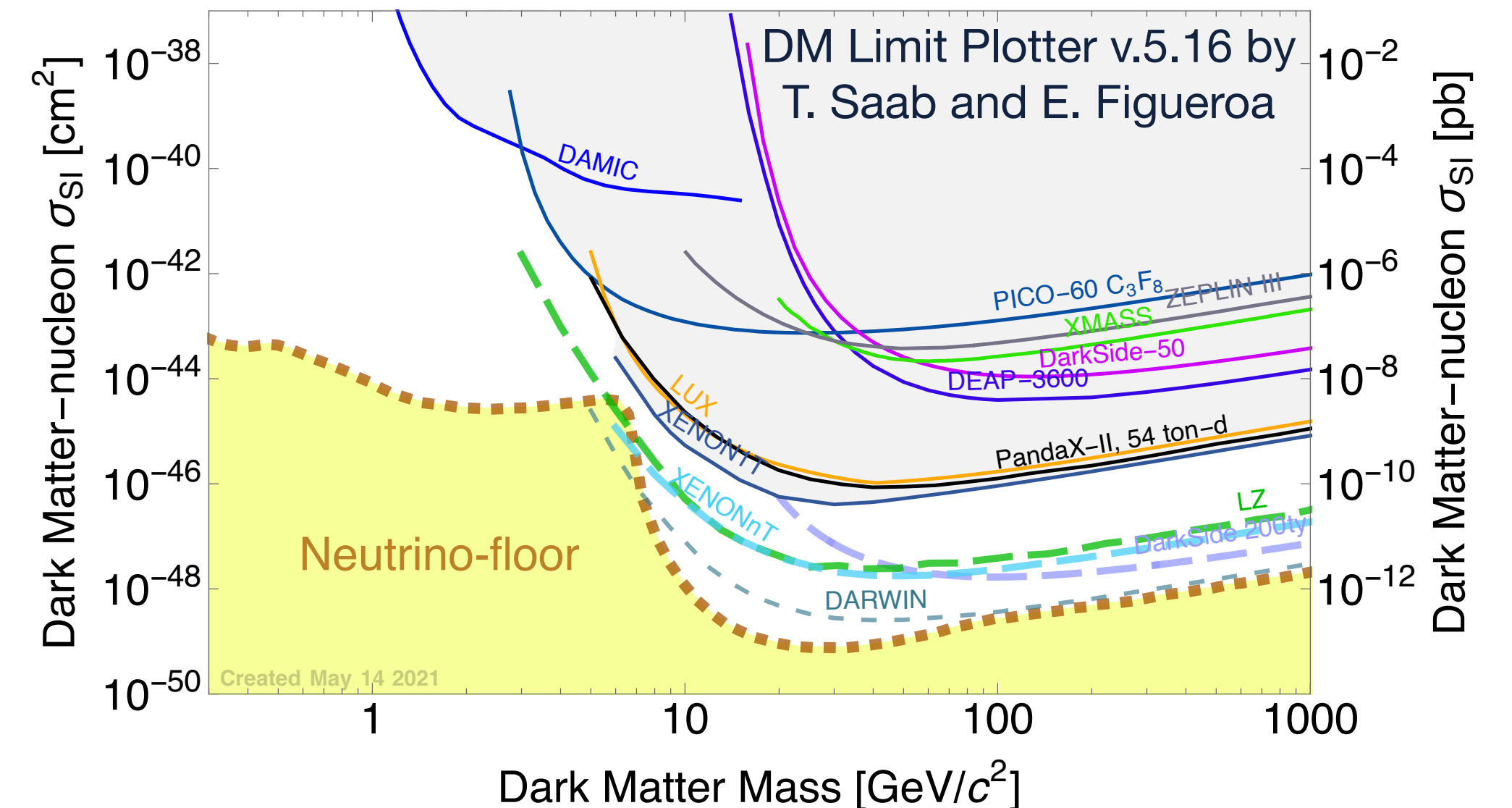
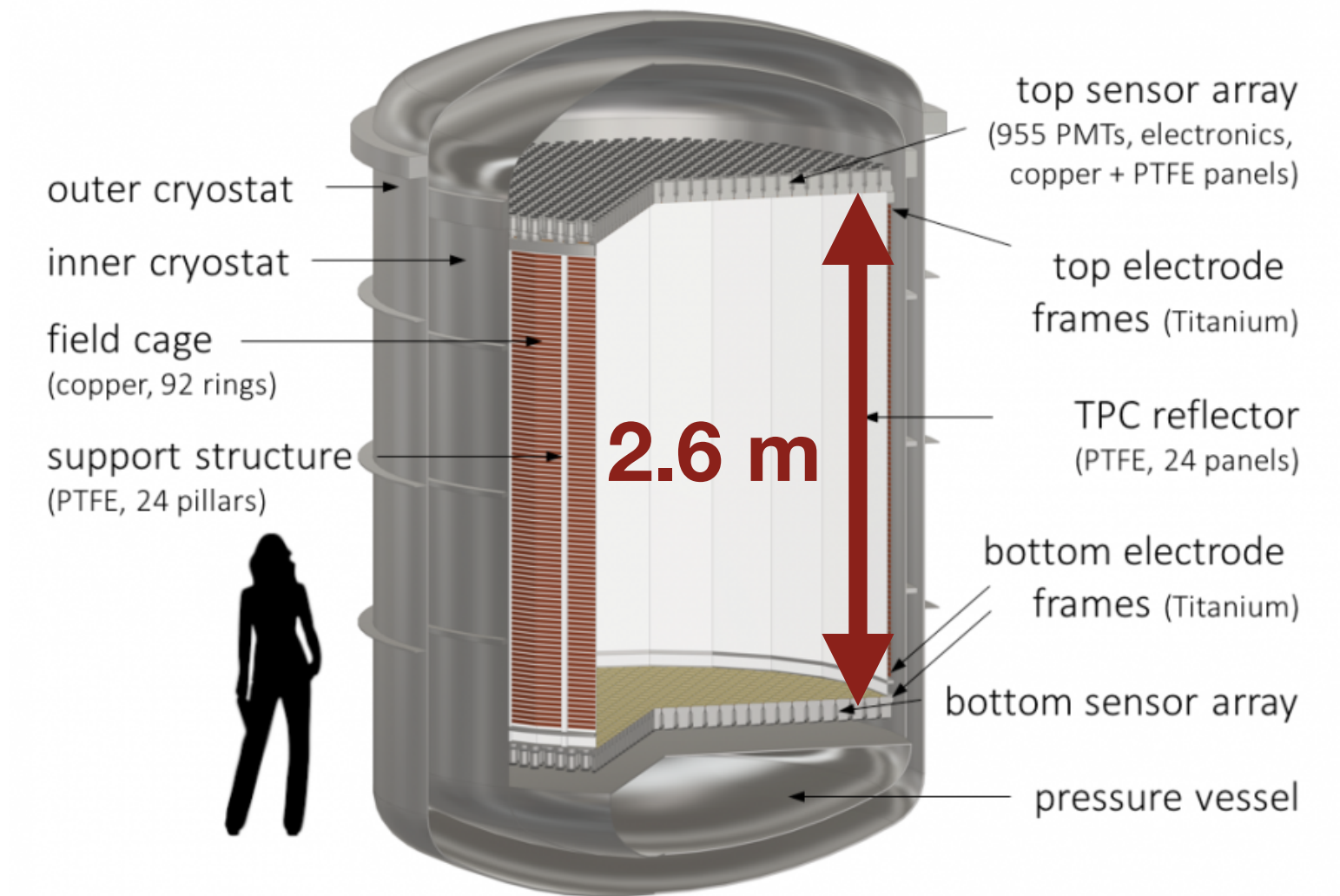

# DARWIN



Universität  
Zürich<sup>UZH</sup>



Thank you for watching!

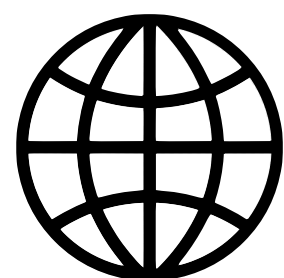

[darwin.physik.uzh.ch](http://darwin.physik.uzh.ch)

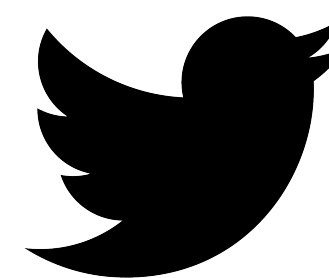

[twitter.com/darwinobserv](https://twitter.com/darwinobserv)